

6-Light Vanity

Part Number

A3136-BN

A3136-CH

Finish

Brushed Nickel

Chrome

Project _____

Date _____

Type _____

Location _____

Product Specifications

Description The embossed, wall-mount bracket of our 6-Light Racetrack Vanity from the Milano Collection has a Hollywood-like appeal. Perfect for use in powder rooms and bathrooms.

Dimensions 36" Width x 4-3/4" Height x 5-3/4" Extension
Extension includes lamp

Lamps 6 x LED G25 (E26 Medium Base) not included

Certifications cETLus Listed | CSA Certified
Suitable for damp locations

Features 120V | 60Hz
Wall mount only (hardware included)
Can be installed horizontally or vertically

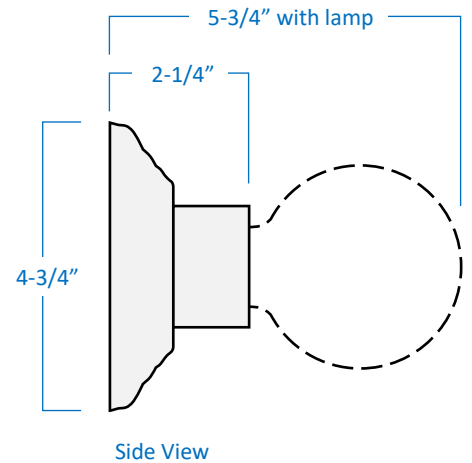

Brushed Nickel

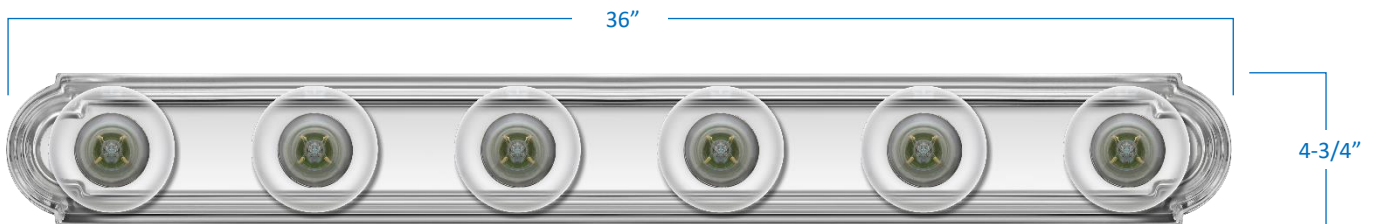

Chrome



GTA Office: 151 Aviva Park Drive, Woodbridge
Ottawa Office: 200 Iber Road, Unit 5, Stittsville

Tel: 905-669-1230
Tel: 613-836-1977

www.sanremolighting.com
© All rights reserved