

2-Light Flush Mount

Part Number **Finish**
A58032-CH Chrome
A58032-BN Brushed Nickel

Project _____
Date _____
Type _____
Location _____

Product Specifications

Description	L'Aquila Collection: This flush mount's refined design provides a sophisticated accent to any contemporary home décor.
Shade	White opal glass with clear rim
Dimensions	12" Diameter x 4-1/4" Height
Lamps	2 x LED A19 (E26 Medium Base) not Included
Certifications	cULus Listed CSA Certified
Features	120V 60Hz Ceiling mount only (hardware included)



Chrome



Brushed Nickel

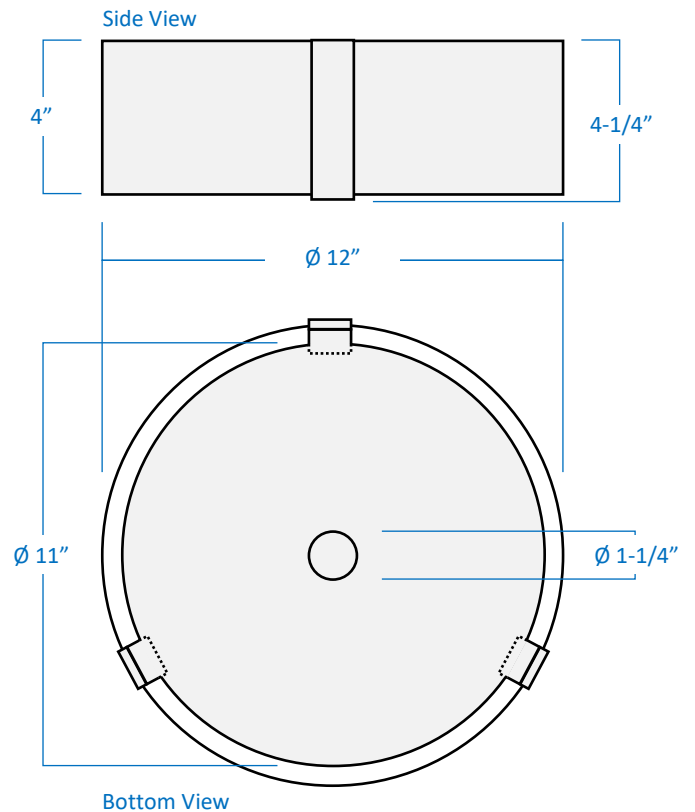

FIXTURE FULLY ASSEMBLED



GTA Office: 151 Aviva Park Drive, Woodbridge
Ottawa Office: 200 Iber Road, Unit 5, Stittsville

Tel: 905-669-1230
Tel: 613-836-1977

www.sanremolighting.com
© All rights reserved